



On Load By Pass Switch

For IT & Telecom Application



Salient Features

- » Range : 125A to 1600A, 415V, AC-23A
Conforms to IS/IEC:60947-3
- » By Pass Switch is designed to specific need in IT industry and applications where UPS and Servo stabilizer provides main source of supply.
- » Presence of Arc chute plates enhances contact life
- » Enhanced Mechanical & Electrical life
- » Total safety : All moving and live parts covered





On Load By Pass Switches



Function

HPL cubicle ON LOAD BY PASS SWITCH connects normal supply to the loads in case stabilized source fails. It by passes the UPS / Servo stabilizers in case of their failures and provides a means of connecting alternative supply to the load. By pass switch also ensure the Isolation of up stream & down stream circuit in one operation.

Operation

Selections of Position

- 0 Loads are open circuited
- I Loads are connected to the stabilized supply.
- II Loads are connected to the normal supply.

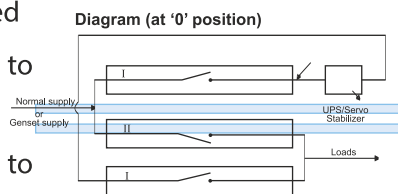

HIGHLIGHTS

- » 100% Neutral rating... true 4 pole switch
- » Line load reversibility
- » Suitable for both aluminum & copper termination
- » Terminal cover, source separator, phase barrier as standard feature
- » Bridging bars mounted on all ratings as standard feature
- » Resistant to Tropical conditions & polluted environment
- » High thermal & dynamic withstand capacity
- » Self extinguishing fiberglass reinforced insulating body
- » Unique Safety Handle with built in door padlock facility
- » 3 lock pad lock, lockable in ON & OFF positions
- » High Electrical & Mechanical life

Application

HPL BY PASS SWITCH is designed to meet customers specific need in the IT companies where UPS & Servo Stabilizer provide main source of supply. In emergency normal supply can be made available to services without disturbing any installation and at the same time providing time for maintenance of UPS etc. without breakdown of services.



- Terminal Shroud & Phase barrier as standard design product
- Enclosed operating rod
- 3 lock pad lockable handle in both ON & OFF positions



Self Fire Extinguishing



Load Line Reversibility



Positive Isolation

Approvals & Test

- Time tested
- Customer Accepted
- CPRI Tested
- ISO 9001 Certified



Globally Accepted
exporting to over
25 countries





On Load By Pass Switches



Design with Total Safety

Stationary contacts for R, Y, B, N Phase are fixed to the moulded housing. 4 sets of moving contacts housed in a carrier are moved towards right for ON or left for OFF. The moving contacts slide on to the stationary contacts to make the circuit.

Arc Chute Plates

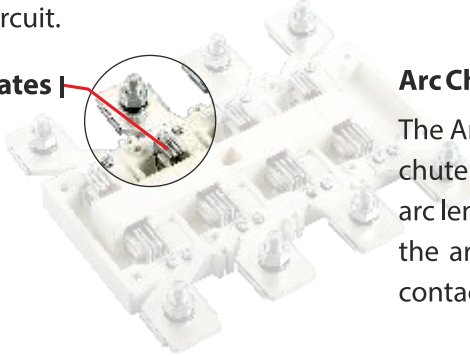

Arc Chamber

The Arc Chamber is specially designed and provided with arc chute plates with an arc channel as a flow guide to reduce the arc length, thereby improving the capability of extinguishing the arc. This enhances the life of the moving & stationary contacts thereby increasing the life of the product.

Accessories

Handle up to 320A



Handle with padlock lever

Handle from 400A and above

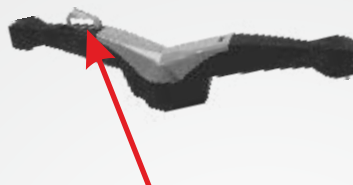

Double Sided Handle with padlock lever

Auxiliary Contact Kit



Bridging Bars



Castell Lock



Extended Shaft

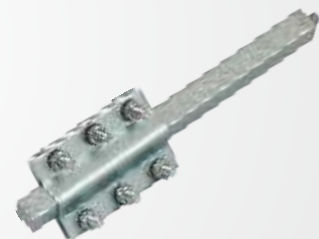

Door Inter Lock Assly.



Inter-Phase barriers

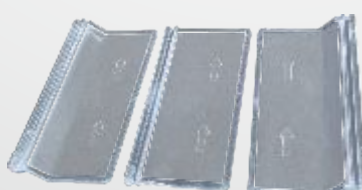

Source Separator & Terminal Shroud

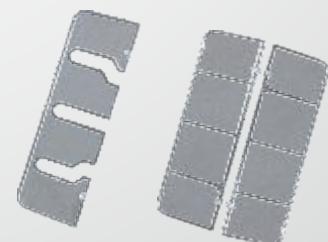



On Load By Pass Switches



By Pass Enclosure



General Characteristics

- Black Handle Padlockable in I - O - II position
- CRCA Sheet (Door 1.2 mm & Body 1.6mm)... 125A to 800A
- CRCA Sheet (Door & Body both 2.0mm)... 1000A to 1600A
- RAL 7035
- 2 External earthing points on each side
- Wall mounted with 4 bolts
- Door locking system allows opening of door only in OFF position
- Incoming & outgoing easily interchangeable at site
- Coating of epoxy polyester powder 70 micron
- Removable plate top & bottom
- Door with solid hinges

References and Dimensions

Rating	L (Length)	W (Width)	H (Height)	X	Y
125A to 200A	290	365	330	325	320
250A to 320A	350	455	356	415	380
400A to 630A	475	575	454	515	525
800A	550	680	568	620	600
1000A to 1600A	800	655	568	600	825

ALL DIMENSIONS ARE IN mm

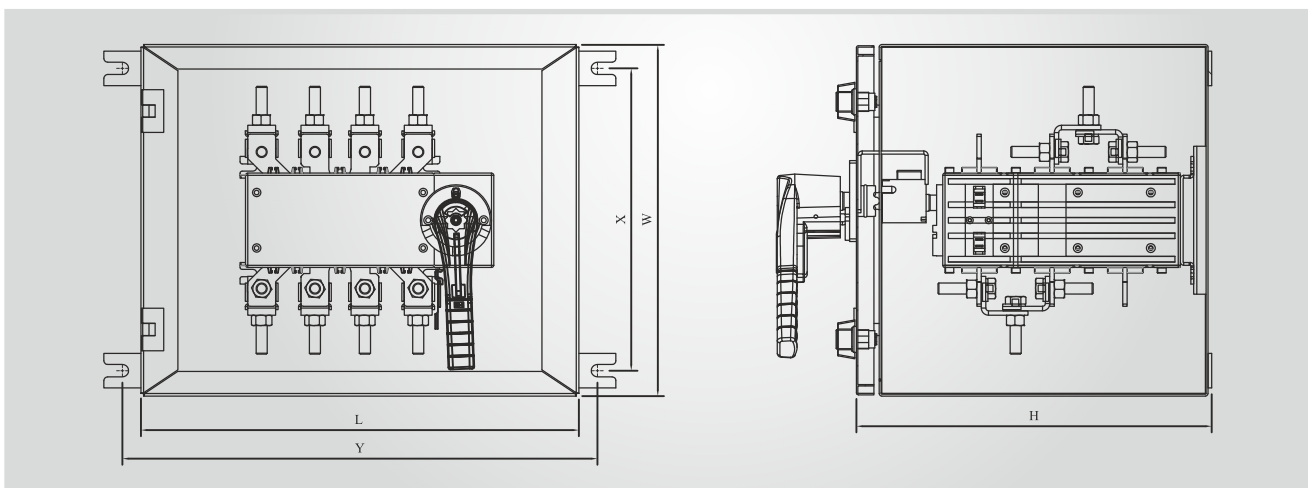



On Load By Pass Switches



Dimensional Details :

BY PASS SWITCH 125A-630A

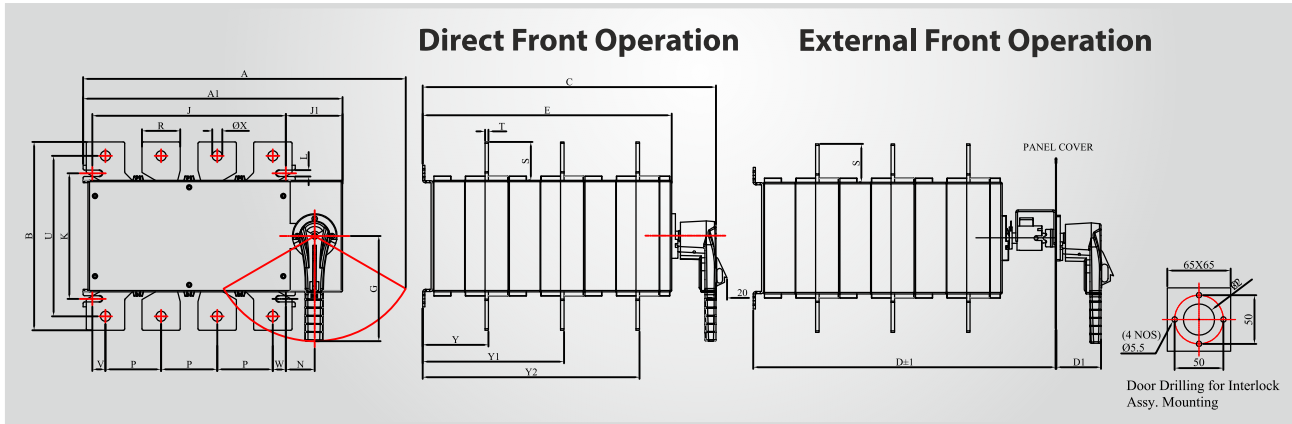

RATING	OVER ALL DIMENSION						FIXING OF SWITCH						CONNECTION TERMINAL										SW. WT.		
	A	A1	B	C	D	D1	E	G	J	J1	K	L	N	P	R	S	T	U	V	W	ØX	Y	Y1	Y2	Open Ex.
4 x 125A	305	228	155	288	302	65	226	116	162	57	95	6.5	26	44	22	28	3	118	15	15	8.5	64	130	195	6.0 Kg.
4 x 160A	305	228	155	288	302	65	226	116	162	57	95	6.5	26	47	25	35	4	123	10.5	10.5	10	64	130	195	7.0 Kg.
4 x 200A	305	228	155	288	302	65	226	116	162	57	95	6.5	26	47	25	35	4	123	10.5	10.5	10	64	130	195	7.0 Kg.
4 x 250A	390	290	192	322	340	65	255	150	217	61	111	6.5	27	64	32	46	4.5	152	9.5	15	12.5	72	148	223	10.0 Kg.
4 x 320A	390	290	192	322	340	65	255	150	217	61	111	6.5	27	64	32	46	4.5	152	9.5	15	12.5	72	148	223	10.0 Kg.
4 x 400A	472	372	270	420	430	65	256	150	280	80	180	9	40	72	40	40	5	206	30	30	11	95	203	310	20.0 Kg.
4 x 630A	472	372	270	420	430	65	356	150	280	80	180	9	40	80	55	55	5	230	20	20	14.5	95	203	310	26.0 Kg.

ALL DIMENSIONS ARE IN mm

BY PASS SWITCH 800A-1600A

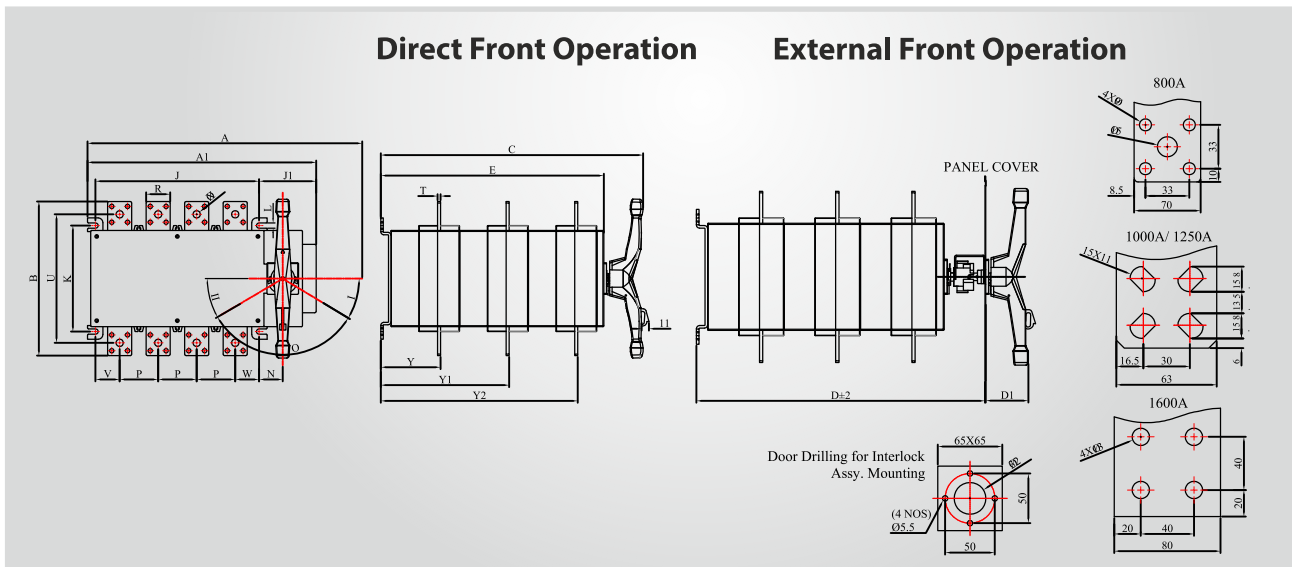

RATING	OVER ALL DIMENSION						FIXING OF SWITCH						CONNECTION TERMINAL										
	A	A1	B	C	D	D1	E	G	J	J1	K	L	N	P	R	T	U	V	W	ØX	Y	Y1	Y2
4 x 800A	572	440	320	545	540	81	464	165	340	116	220	11	49	80	50	6	267	50	50	15	124	266	409
4 x 1000A	705	572	330	545	540	81	464	165	474	116	220	11	49	120	63	6	273	63	50	15	124	266	409
4 x 1250A	705	572	330	545	540	81	464	165	474	116	220	11	49	120	63	7	273	63	50	15	125	267	410
4 x 1600A	705	572	361	545	540	81	464	165	474	116	220	11	49	120	80	15	281	63	50	15	129	271	414

ALL DIMENSIONS ARE IN mm



On Load By Pass Switches



Specification Electrical & Mechanical Characteristic

Specification

Current Rating

Frame Sizes	Frame-1			Frame-2		Frame-3		Frame-4	Frame-5		
Thermal Current (Ith) 40°C	125A	160A	200A	250A	320A	400A	630A	800A	1000A	1250A	1600A
Max. Normal rating of fuses	125	160	200	250	315	400	630	800	1000	1250	2 x 800
Insulation voltage Ui (Vac)	1000	1000	1000	1000	1000	1000	1000	1000	1000	1000	1000
Dielectric strength (Vac) 50 Hz 1 minute	5000	5000	5000	5000	5000	8000	8000	8000	8000	10000	10000
Impulse voltage (KV)	6	6	6	8	8	12	12	12	12	12	12

Rated Operational Current Ie (A)

415 Vac: AC 23A	125	160	200	250	320	400	630	800	1000	1000	1000
500 Vac: AC 23A	100	130	160	200	250	315	315	630	1000	1000	1000
260V dc: DC 21A	125	160	200	250	320	400	630	800	1000	1250	1600
DC 22A	125	160	200	250	320	400	500	800	1000	1250	1250
DC 23A	125	160	160	200	250	400	500	800	1000	1250	1250
440V dc: DC 21A	125	160	200	250	320	400	500	630	1000	1250	1600
DC 22A	125	130	160	200	250	400	500	800	1000	1250	1250
DC 23A	125	130	160	200	250	400	500	800	1000	1000	1000

Motor Power (KW) 415V

415 Vac without pre break Aux. Contact	63	70	80	132	160	200	220	450	560	560	560
500 Vac without pre break Aux. Contact	60	63	63	140	220	220	220	450	560	560	710
690 Vac without pre break Aux. Contact	50	55	55	90	150	150	150	185	400	400	475
415 Vac with pre break Aux. Contact	63	70	80	132	160	220	355	450	560	710	710
500 Vac with pre break Aux. Contact	70	80	80	160	220	280	355	550	710	710	900
690 Vac with pre break Aux. Contact	100	110	110	110	220	220	295	475	600	600	750
Motor Reactive 415 Vac (kVAR)	50	55	60	100	125	150	2x125	2x150	3x150	4x125	5x150

Overload Capacity

Short circuit current with fuses (kA RMS)	80	80	80	80	80	80	80	80	80	80	80
Fuse Rating	125	160	200	250	315	400	630	800	1000	1250	2x800
Peak short circuit making capacity (kA RMS)	20	20	20	30	45	45	45	55	105	105	110
Admissible short time current 1 sec (kA RMS)	7	7	7	13	13	13	13	26	50	50	50

Making & Breaking Characteristics

Breaking capacity (A RMS) 415 Vac pf=0.35	1000	1280	1600	2000	2520	3200	5040	6400	8000	8000	8000
Making capacity (A RMS) 415 Vac pf=0.35	1250	1600	2000	2500	3150	4000	6300	8000	10000	10000	10000

Endurance

Mechanical Life (No. of Operations)	8000	8000	8000	8000	5000	5000	5000	4000	4000	4000	3000
Electrical Life (No. of Operations)	1000	1000	1000	1000	1000	1000	1000	500	500	500	500
Operating Torque (N-m)	9.5	9.5	9.5	11	11	17	17	40	40	40	40

Connection

Min. Cu. Cable / Bus bar size (mm ²)	50	70	95	120	185	30x5x2	40x5x2	50x5x2	60x5x2	80x5x2	100x5x2
Min. Al. Cable / Bus bar size (mm ²)	70	95	150	185	240	32x8x2	40x8x2	50x8x2	50x10x2	63x12x2	100x8x2

HPL Electric & Power Ltd

Corp. Office : Windsor Business Park, B-1D, Sector-10,
Noida, U.P. - 201301, INDIA.

Tel.: +91-120-4656300, Fax: +91-120-4656333

Registered Office : 1/20, Asaf Ali Road, New Delhi - 110 002, INDIA.

E-mail : hpl@hplindia.com; enquiry@hplindia.com

Customer Care No. :
18004190198

www.hplindia.com

- | | | | | | | |
|----------------------------|-------------------------|---------------------------|-------------|---------------|---------------|--------------|
| • Ahmedabad 079-66168835 | • Indore 0731-4280525 | • Vijayawada 0866-6622291 | • Davangere | • Kanyakumari | • Nasik | • Srinagar |
| • Bangalore 080-22863068 | • Jaipur 0141-4021035 | • Vizag 0141-4021035 | • Goa | • Kolhapur | • Patiala | • Sambalpur |
| • Bhubaneswar 0674-6538229 | • Kanpur 0512-2316017 | • Agartala 033-22252716 | • Belgaum | • Gorakhpur | • Patna | • Tirupati |
| • Chandigarh 0172-2639157 | • Kolkata 033-22252716 | • Agra | • Berhampur | • Gulbarga | • Pondicherry | • Trichy |
| • Chennai 044-28551537 | • Lucknow 0522-4021687 | • Allahabad | • Bhilai | • Jabalpur | • Rajkot | • Trivandrum |
| • Cochin 0484-2354595 | • Mumbai 022-61830814 | • Anantpuram | • Bhopal | • Jabli | • Rourkela | • Udaipur |
| • Coimbatore 0422-4393995 | • Nagpur 0712-2222988 | • Aurangabad | • Bilaspur | • Jammu | • Salem | • Vapi |
| • Dehradun 0135-2710567 | • Pune 020-69200902/01 | • Amravati | • Bijapur | • Jamshedpur | • Siliguri | • Varanasi |
| • Guwahati 0361-2450889 | • Raipur 0771-6541590 | • Akola | • Calicut | • Jalandhar | • Surat | • Vellore |
| • Hubli 0836-4251463 | • Ranchi 0651-2206144 | • Angul | • Cuttack | • Jharsuguda | • Mysore | |
| • Hyderabad 040-40035959 | • Vadodara 0265-2341747 | • Bareilly | | • Jodhpur | • Nagercoil | |